

# Flo-Well<sup>®</sup>

STORM WATER LEACHING SYSTEM



**One source.  
Many solutions.**



# APPLICATIONS

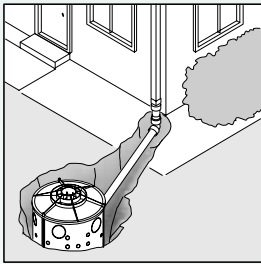

**For gutters and downspouts**

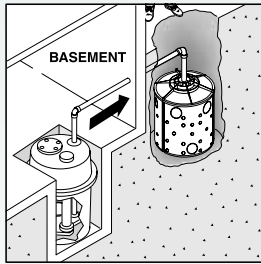

**Install with sump pump**

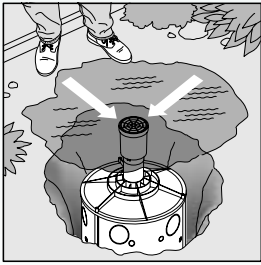

**Eliminates puddles**

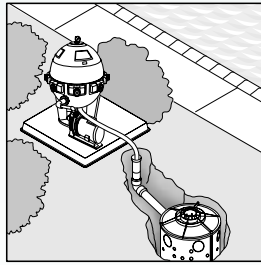

**Pool backwash tank**

# OPTIONS

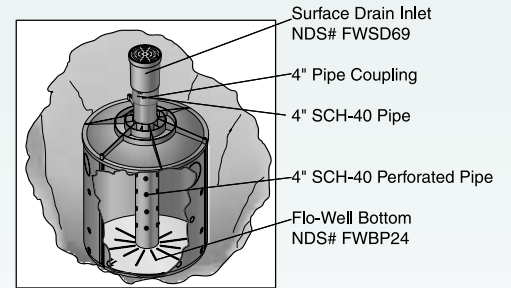

**For additional support**

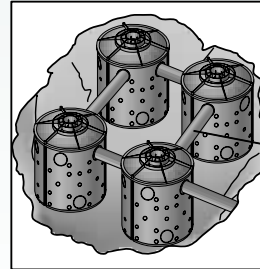

**Can be connected**

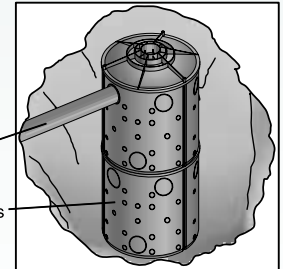

**Can be stacked**

# INSTALLATION

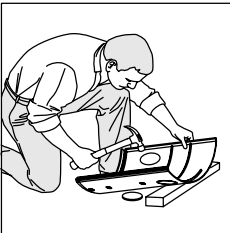

**1 Knock out ports as needed from inside of panel**

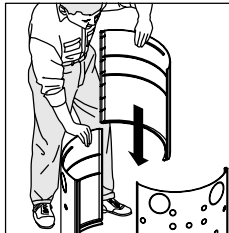

**2 Slide panels together**



**3 Optional Filter Fabric to prevent sand and debris from entering Flo-Well**



**4 Place in ground and set top cover in place\***

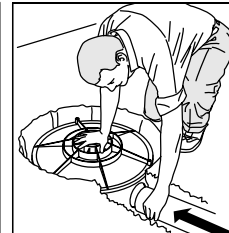

**5 Install pipe or surface drain**

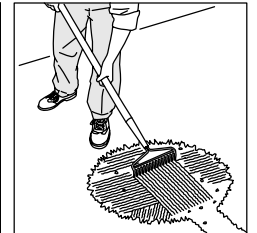

**6 Bury to minimum of 8 inches deep**

*Installation Note: Location and number of ports removed will determine the rate and direction of leaching.  
\* Add gravel around outside of Flo-Well unit to increase leaching capacity.*

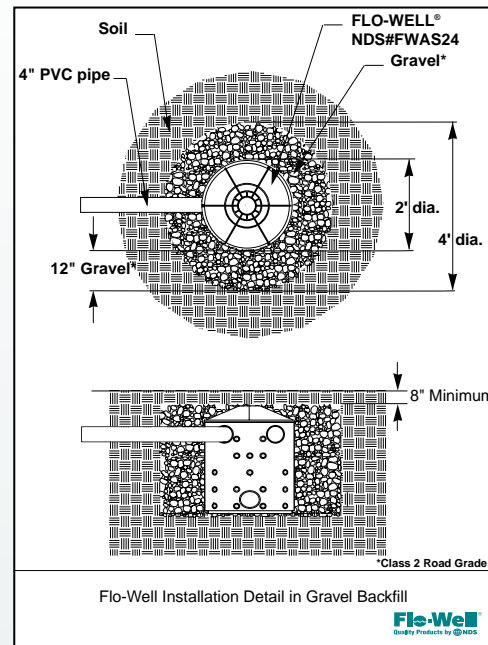
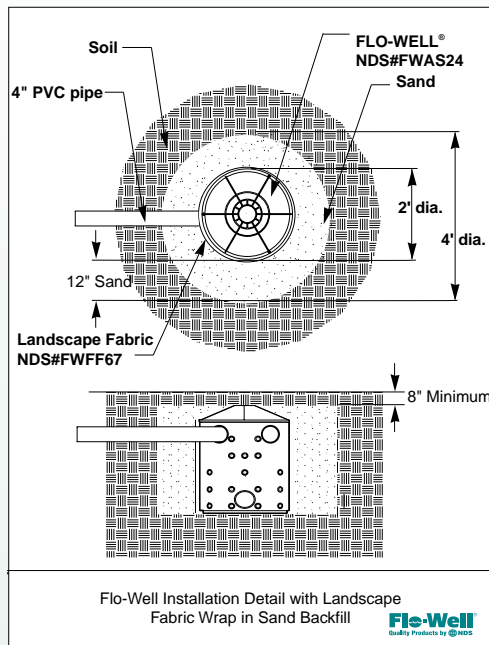

# STORM WATER LEACHING SYSTEM

	Part No.	Description	Color	Pkg. Qty.	Specifications
	FWAS24	24 x 28.75" Round Dry Well System  Includes 3 side panels, 1 Top Component	Black	1	NDS #FWAS24 structural foam polyolefin round drywell system with UV inhibitors. 24" dia., 28.75" high, 49 gal. with 18- 1.5" Knockout leaching ports and 3- 4.5" knockout inlet/outlet ports per panel.
	FWAS24C	24" Flo-Well® Cover  Use with NDS #FWAS24	Black	1	NDS#FWAS24C structural foam polyolefin round drywell system cover with UV inhibitors. 24 1/4" dia., 4 5/8" height, 3/4" outer lip, 4.5" center knockout fits NDS #FWAS24, NDS #FWSPS3
	FWSPS3	Flo-Well® Side Panels/ Extension Only  Includes 3 side panels Fits NDS #FWAS24	Black	3	NDS #FWSPS3 structural foam polyolefin side panels with UV inhibitors with 18- 1 1/2" knockout leaching ports and 3- 4.5" knockout inlet/outlet ports per panel. 24" high with recessed .75" lip for firm stacking.
	FWBP24	24" Flo-Well® Bottom  Fits NDS #FWAS24	Black	1	NDS #FWBP24 structural foam polyolefin round Flo-Well® bottom with UV inhibitors. 24" diameter with six 1 1/2" leaching ports. 4.5" center knockout for strut coupling.
	FWSD69	4" SCH40 Surface Drain Inlet with Grate  Fits NDS #FWAS24	Black	1	NDS #FWSD69 structural foam polyolefin 6" grate with 4" inlet with UV inhibitors. 6" Diameter at inlet. 9" high. 4.5" OD fits Sch. 40 PVC fittings.
	FWFF67	Porous Filter Fabric Wrap for Flo-Well®  Use with NDS #FWAS24	Black	1	7' long x 2' wide to surround Flo-Well® Drywell System. Non-woven fabric. Weight 1 oz. Mullen burst 175 psi. 200 GPM flow through.

# Flo-Well® Table

## Formula for Number of Flo-Wells per Drainage Area:

Number of Flo-Wells to use per Drainage Area:  

$$\frac{[\text{Water Runoff Volume into Flo-Well}] \times [\text{Coefficient of Ground Under Flo-Well}] + [\text{Volume of Backfill Material}]}{[\text{Volume of Flo-Well } (7.527\text{Ft}^3)]}$$
  
 Volume of Water Runoff into Flo-Well:  

$$\frac{[\text{Sq. Ft. Area} \times \text{Coefficient of Runoff}]}{12}$$
  
 Volume of Backfill Material:  

$$\frac{\pi}{4} \times (\text{Diameter of Backfill Material}^2 - \text{Diameter of Flo-Well}^2) \times \text{Depth of Flo-Well} \times (1 - \text{Coefficient of Runoff for Backfill Material})$$

Flo-Well Calculator can be found at:

[www.NDSPRO.com/Flo-Well](http://www.NDSPRO.com/Flo-Well)

## 12 Steps to Complete Formula

(Example calculations are shown in Red)

Figure A

### Finding The Drainage Area

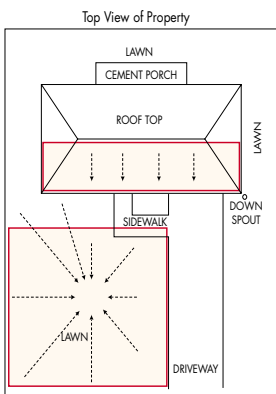

**DRAINAGE AREA** is defined as a single collection area that brings the water to one point of discharge. The property diagram above shows the typical breakdown of drainage areas per property. The dashed lines show water flow.

Roof Top Measurement

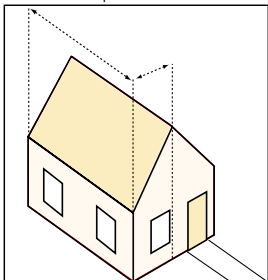

For Calculating the dimensions of a roof drainage area, use only the length and width of the foundation below the roof.

### Step 1: Square Footage of Drainage Area(See Figure A)

Length of Drainage Area: a) 50  
 Width of Drainage Area: b) 50  
 a) 50 X b) 50 = c) 2500 Sq.Ft.

### Step 2: Coefficient of Runoff for Drainage Area(See Figure B)= d) 0.6

### Step 3: of Water from Drainage Area:

c) 2500 X d) 0.6 ÷ 12 = e) 125 Cu.Ft.

### Step 4: Coefficient of Runoff for Backfill Material(See Figure B)= f) 0.5 (Concrete and Asphalt are not recommended for backfill materials)

### Step 5: Diameter of Backfill Material(See Figure C): g) 4 Ft. X g) 4 Ft. = h) 16 (Both Numbers placed in g) should be the same and greater than 2)

### Step 6: 1 - f) 0.5 = i) 0.5

### Step 7: h) 16 - 4 = j) 12

### Step 8: Volume of Backfill Material:

i) 0.5 X j) 12 X 2.356194 = k) 14.137 Cu. Ft.

### Step 9: Coefficient of Runoff for Soil Under Flo-Well(See Figure D)= l) 0.4

### Step 10: e) 125 X l) 0.4 = m) 50

### Step 11: k) 14.137 + 7.527 = n) 21.664

### Step 12: m) 50 ÷ n) 21.664 = 3 # of Flo- Wells needed for Drainage area.

Figure B

Soil Texture	Coefficient of Runoff
Roof Top	1
Concrete/Asphalt	1
Gravel -Compact	0.7
Clay - Bare	0.75
Clay - Light Vegetation	0.6
Clay - Dense Vegetation	0.5
Gravel - Bare	0.65
Gravel - Light Vegetation	0.5
Gravel - Dense Vegetation	0.4
Loam - Bare	0.6
Loam - Light Vegetation	0.45
Loam - Dense Vegetation	0.35
Sand - Bare	0.5
Sand - Light Vegetation	0.4
Sand - Dense Vegetation	0.3
Grass Areas	0.35

Figure C

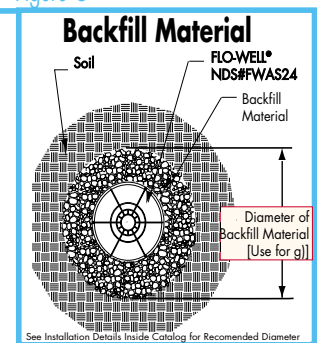
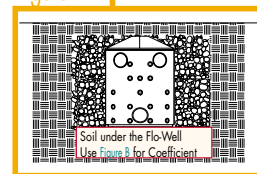

Figure D



#### NOTE:

Where local regulations do not apply, NDS recommends that your drainage system be designed with downspout drains based on the first inch of precipitation during each storm session. In the event of a storm producing precipitation of more than one inch, additional overflow precautions are recommended.

Due to variances in soil conditions, actual water storage capacity and water distribution capabilities of the Flo-well system may vary. Please consult an engineer for detailed storage capacities. The example figures in red are for sample purposes only.

The Flo-Well table (Flo-Well Calculator) can be found in an automated format at [www.NDSPRO.com/Flo-Well](http://www.NDSPRO.com/Flo-Well).