

SRC Plus Controllers

*Professional-Grade
Residential/Light Commercial Controller
with Optional SRR Remote Control System*

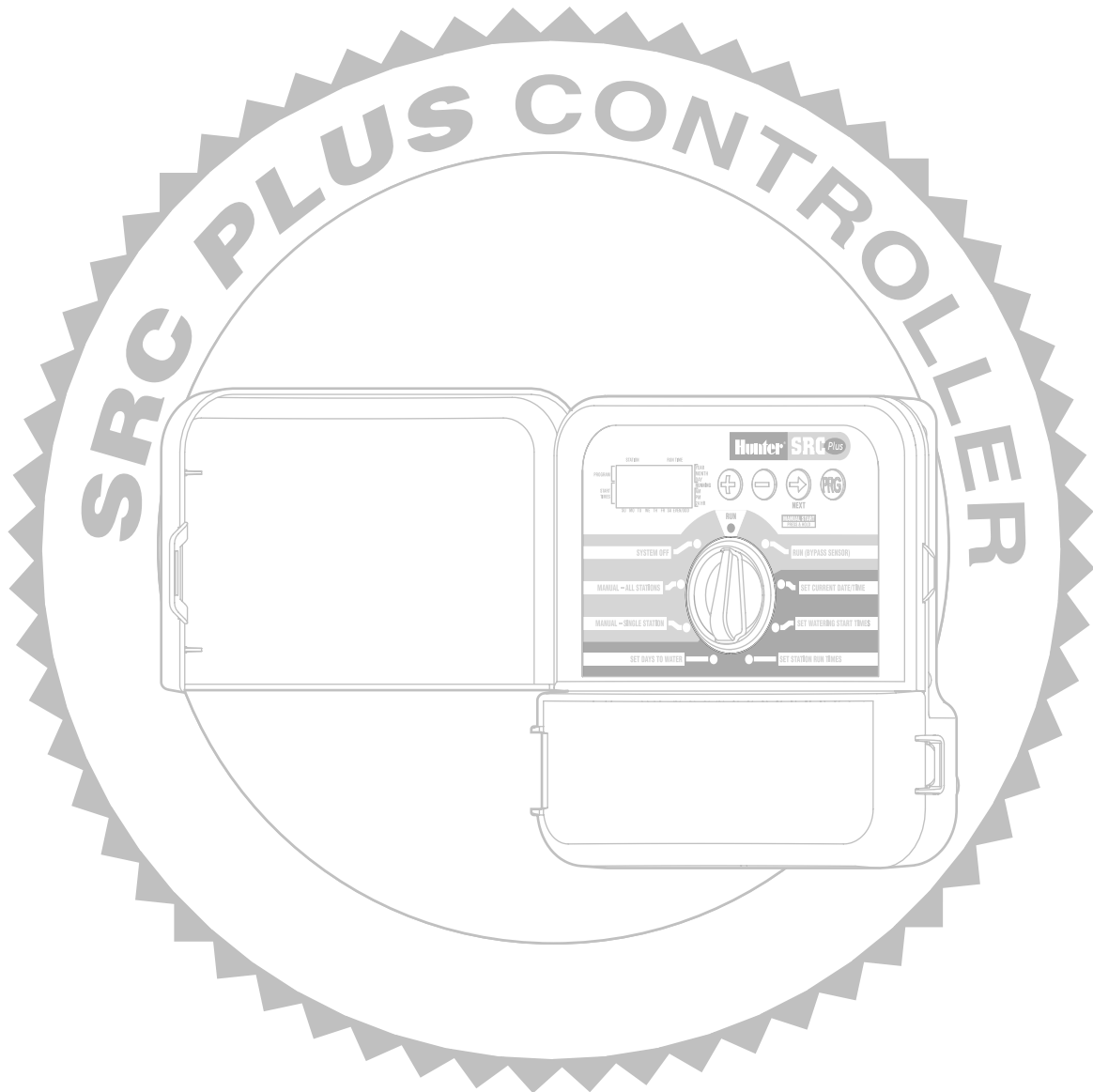

TABLE OF CONTENTS

SRC *Plus* Controllers

Product Overview	1
Product Features and Benefits	2
SRC <i>Plus</i> Components	8
Technical Information.....	9
Product Comparisons.....	10
Installation	11
Programming	15
Troubleshooting Guide	20

Optional SRR Remote Control for Residential Systems

Product Overview	21
Product Features and Benefits	22
SRR Components	24
Installation and Programming	25
A Word About Range.....	29
Troubleshooting Guide	30
Technical Information.....	31
Installation Details.....	32

PRODUCT OVERVIEW

An affordable controller for residential and light commercial applications – Hunter's SRC *Plus*, the Simple and Reliable Controller.

Designed with the needs of the professional contractor in mind, the SRC offers easy installation, simplified dial programming and an impressive range of features typically found in controllers costing twice as much.

To install the SRC, just attach the mounting bracket to the wall and slide the controller in place (there's no need to remove the circuit board and ample space has been allocated for spare wiring and connections to the terminal block).

The controller's easy-to-understand dial allows you to step through the programming process and activate manual watering with a twist of the wrist (you'll also find the large LCD display makes viewing a breeze). And, as for features... how about a choice between a 6- or 9-station model, Remote Control Ready, three full programs with up to four daily start times each, a one-touch start and rapid manual advance that allows the user to quickly start a program or check out the system, a built-in 365-day calendar clock, a rain sensor bypass circuit and primary power surge protection (just for starters)?

The Hunter SRC. The professional grade controller that's an economical value. You'll find it's easy to install, easy to program and priced so it's hard to resist.



PRODUCT FEATURES AND BENEFITS

Best Value for Residential...

With 6 or 9 stations for complete versatility

Hunter is supplying both a 6-station and a 9-station controller model. By offering a wide range of features and reliable operation at a competitive price, the SRC Plus is an excellent value.

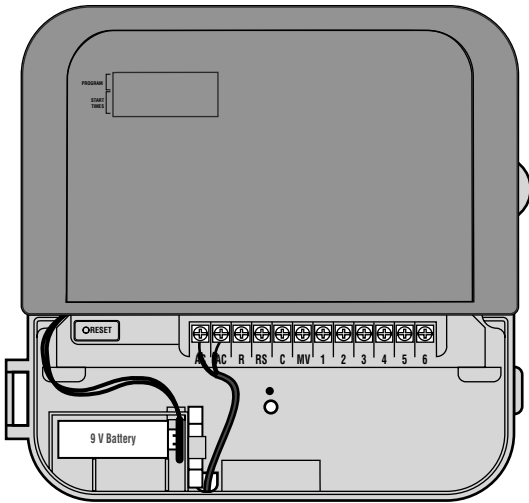

Dial Programming...

Easy program entry

For contractors and homeowners alike, the SRC provides step by step programming. No complicated entry functions or repetitive keystrokes.

3 Programs (A, B, C) with Multiple Start Times...

Different watering requirements are met with independent programming

The SRC allows for many different irrigation applications using three completely independent programs. This is ideal for various types of plants that have separate watering day requirements. Each program has the ability to water up to four start times per day. The user has complete flexibility with watering schedules for new

seed or sod lawns, multiple cycles for low infiltration-rate soils, slopes, morning or evening irrigation and other watering window restrictions.

365-day Calendar with Leap Year Intelligence...

True odd or even day programming

In many areas of the United States, summer water rationing is a way of life. With its 365-day, leap year intelligent calendar the SRC makes programming true Odd/Even day watering possible, automatically correcting for 31-day months. Interval or Day of the Week scheduling is possible as well, to cover any watering day restrictions that may be enacted.

Large, Heavy Duty Cabinet...

With a professional appearance

Not only is the SRC's standard indoor cabinet good looking and extra sturdy, it also includes provisions for conduit that allow for a professional installation. Install with or without the protective door for a finished appearance.





Large LCD display...

Easy to read

The large LCD display simplifies programming by making the controller entries easy to read and verify. Symbols and numbers on the display make it easy to understand in any language.



Remote Ready...

Provide your controller with simple and reliable operation away from its mounting location

The SRC *Plus* is remote ready! A SmartPort® wire harness is supplied with the SRC controller to permit the attachment of a Hunter SRR remote receiver. The easy-to-install handy option can help save time and effort by allowing remote valve operation away from the controller.





One Touch Start and Rapid Manual Advance...

Activate stations to water without using the dial

A special feature that Hunter has incorporated into the SRC is called the One Touch Start and Manual Advance.

It has increased the user-friendliness of the controller with fewer steps to activate stations without the use of the dial. This feature is great for a quick start of a cycle when extra watering is needed or if you would like to scroll through the stations in sequential order to inspect the irrigation system.



Procedure to operate the Manual Start Feature for an extra watering cycle

1. Press the  button for 2 seconds.
2. Station run time will flash in the display. This feature automatically defaults to program A. You can select program B or C by immediately pressing the  button before the number stops flashing. *To operate the entire program as scheduled, no other handling is required. After a 2 second pause, the program will begin.*
3. If a particular station needs a onetime adjustment to its run time for this cycle then press the button (while the run time is flashing) to scroll through the stations until the desired station number appears. Use the  or  button to adjust the station run time. The controller will begin to operate that station within 2 seconds. (If no buttons are pressed during step 2 or 3, the controller will automatically begin program A.) After the selected station has completed its altered run time the controller will then proceed to water subsequent stations, with their original programming, in sequential order only. It will not water previous stations.

PRODUCT FEATURES AND BENEFITS *(continued)*

Procedure to operate the Rapid Manual Advance Feature for a quick system check



1. Press the  button for 2 seconds.
2. Station run time will flash in the display. This feature automatically defaults to program A. You can select program B or C by immediately pressing the  button before the number stops flashing.
3. After a 2 second pause, the program will begin. Press the  button repeatedly to scroll through the stations in the program.

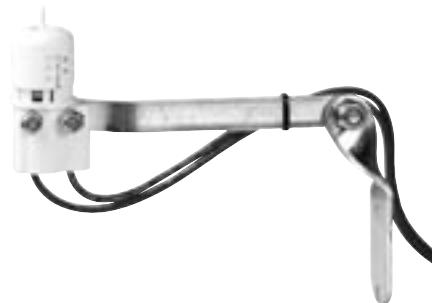

Rain Sensor Bypass... *Simplified override of rain sensor*

With the built-in rain sensor bypass, there is no need for an additional manual bypass switch when using rain sensors. The SRC *Plus* works with most rain and freeze sensors on the market today. If the sensor is preventing system operation, just turn the dial to “Run (Bypass Sensor)” and the rain sensor will be overridden.

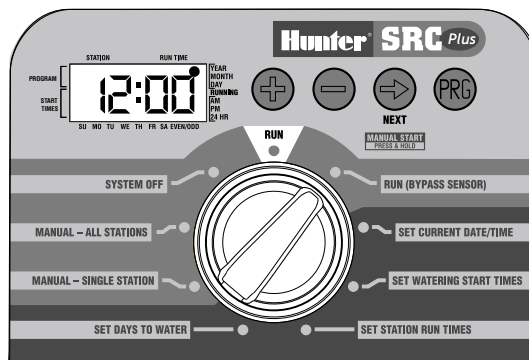

Semi-Automatic Operation... *Manual watering of all stations*

Turn the dial to “Manual-All Stations” and choose either a program or a specific station within that program to start irrigating. Then turn the dial back to run, and the SRC runs through the remaining stations. You may also change the times on a given program to create a custom manual program. After the controller completes the manual watering, it will return to the original schedule.



Easy Access Wiring Compartment... *Simplified wire hookups*

The SRC *Plus* permits fast and easy connection of wiring in the spacious wiring compartment. With the sturdy terminal strip there is no need to hook the wire around the screw on the terminal to make a connection. Instead, simply insert a straight wire end next to the gripping screw and tighten for a positive connection.

Simplified Single Zone Manual Operation...

One station manual operation

The customer may want to manually run a single station, without watering all zones. The SRC allows this to happen by a simple turn of the dial to “Manual-Single Station,” and selecting the zone. The selected zone will run for either the time set in original scheduling or for the specific time set for manual operation after the dial is turned back to the run position. After the controller completes the manual watering, it will return to the original schedule, even if modified for the manual operation.

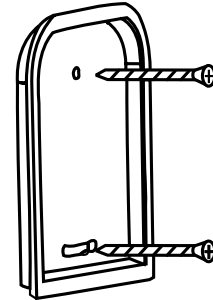

Time Saving Mounting Bracket...

Quicker, neater, easier installation

No need for special mounting templates and directions. With the SRC, just hang the wall bracket and slide the controller onto the bracket. With the special wall bracket there is extra stabilization on the wall and no need to disassemble the unit to access mounting holes in the cabinet.

Electrical Surge Protection...

Protects controller from electrical surges

A built-in MOV (Metal-Oxide Varistor) protects the microcircuitry against electrical surges caused by storms, power fluctuations, brownouts, etc.

Master Valve and Pump Start Relay Circuit...

Compatible with Hunter PSR (Pump Start Relay) and other popular relays

A master valve or Hunter PSR pump start relay can be activated with 24 VAC power by connecting the wires to the C (Common) and MV (Master Valve) terminals on the terminal strip.

PRODUCT FEATURES AND BENEFITS *(continued)*

Programming Instructions...

At-a-glance; always there

The SRC *Plus* provides a reference label that is attached to the inside of the controller door. No more lost or misplaced instructions! Plus, labels for Spanish, French, German Portuguese and Italian languages are also available. Extra space is provided to write in sprinkler zone information.

Run Times...

Accurate watering times per station

Each station can run from **1 to 99 minutes** in 1 minute increments. These run times will prevent the possibility of erroneously scheduling an extremely long run time. Extended run times of up to 6 hours, 36 minutes are possible by scheduling 4 start times back to back on a single program. The default watering schedule for Program A is 10 minutes, everyday beginning at 8:00 AM.

Rain Off...

Easy system shutdown

When wet weather or winterization is a factor, turn the



dial to the “System Off” position and all watering will be suspended indefinitely. To return to automatic operation, simply turn the dial to “RUN” or “RUN (Bypass Sensor).” All the scheduling information is stored in the controller and is not affected by the “System Off” setting.

Interchangeable Faceplate Label...

Allows for language customization

The faceplate instructions can be changed to either Spanish, French, or Italian by the user in the field. Complete language customization kits include a faceplate label, a door instruction label, and an owner's manual.

Program Overlap Protection...

Assures proper system operation

The SRC assures that no two stations will run concurrently no matter what the start times, irrigation days, or duration of each program. Since most systems do not have excess pressure and flow available, two or more valves operating at the same time can cause inefficient watering. Program overlap protection prevents this from occurring.

Non-volatile Memory...

Holds programs indefinitely; excellent insurance against unreliable power

The SRC has what every user of electronic controllers has wished for: the ability to keep all programs in memory without a backup battery. In the event of a power failure or if AC power is suspended from the controller by the user, the SRC's non-volatile memory will maintain programs forever, without need for a battery. Normal watering will resume when AC power is restored.

Self-Diagnostic Electronic Short Circuit Protection...

No fuses to worry about; only faulty stations stop watering

The SRC *Plus* automatically skips shorted stations allowing the rest of the system to operate as normal. The self-diagnostic electronic short circuit protection system is very beneficial to the user because of its ability to aid in identifying field wiring problems. It is almost as if the controller can troubleshoot the system itself.

The self-diagnostic system detects a high current path – a “short” – through an operating station (the most common causes of shorts are faulty solenoids or when a bare valve common wire touches a bare station control wire). When a short circuit is detected on a station, instead of blowing a fuse which would shut down the entire irrigation system, the controller will skip over that station and continue to water the rest of the zones in the program.



The controller will indicate what zone is shorting by showing the station number followed by ERR in the LCD display. The controller will continue to “jump over” that zone during every watering until the zone is repaired. To remove the ERR message from the display, just turn the dial or push any button.

Upgrade to Centralized Control...

Network through IMMS™ to make programming changes and monitor system conditions from your computer

The SRC can be networked to your computer through the Hunter Irrigation Management and Monitoring System™ (IMMS). The IMMS allows the user to program controller functions that would typically be handled directly at each controller. Scheduling days to water, run times, start times and more can be done from a single computer at a desk miles away from the installation. A key function of the IMMS is its ability to monitor changing conditions with the aid of such options as flow sensors, rain sensors, and other weather-sensing devices. No system available today is more cost effective than the Hunter IMMS. Best of all it is able to team with any or all of the Hunter controllers, including the SRC.

SRC PLUS COMPONENTS

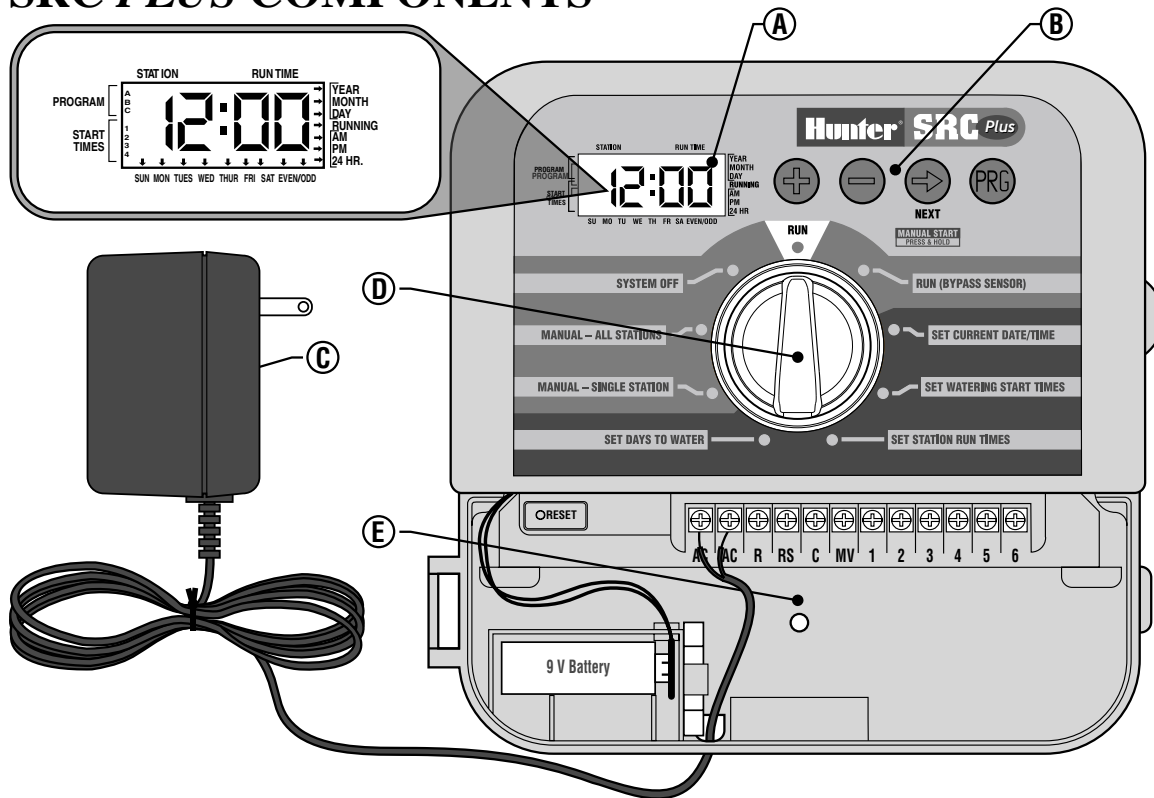

A – LCD Display

- Start Time** – Identifies selected start time (only one start time per program is required).
- Program Designator** – Identifies program in use A, B, or C.
- Station Number** – Identifies currently selected station number.
- LCD Display** – Indicates various times and values.
- Run Time** – Duration of individual stations watering.
- Year** – Current calendar year.
- Month** – Current calendar month.
- Day** – Current calendar day.
- Running** – Indicates when watering is occurring.
- AM/PM** – Arrow differentiates either AM or PM time.
- 24 HR** – 24-hour time is available in addition to AM and PM.
- Day of the Week** – Identifies days of the week to water or you can select to water on odd or even days.
(For all above LCD display items, when an arrow cursor is flashing, that is what you are setting.)

B – Control Buttons

- + Button** – Increases the selected flashing display.
- Button** – Decreases the selected flashing display.
- ➡ Button** – Advances the selected flashing display.
- PRG Button** – Selects program A, B, or C.

C – Transformer

A 120 VAC Plug-in transformer (included in SRC -600i and 900i models) supplies 24 VAC to the controller.

D – Control Dial

- Run** – Normal dial position for automatic and manual operation.
- Run (Bypass Sensor)** – Used to disengage optional weather sensor that may be wired to your system.
- Set Current Date/Time** – Allows current date and clock time to be set.
- Set Watering Start Times** – Allows 1 to 4 start times to be enabled in each program.
- Set Station Run Times** – Allows user to set each station run time from 0 to 99 minutes.
- Set Days To Water** – Allows user to select individual days to water or to select an odd or even watering schedule, according to the date.
- Manual – Single Station** – Allows user to activate a one time watering of a single station.
- Manual – All Station** – Allows user to activate a one time watering of all stations or a few selected stations.
- System Off** – Allows user to discontinue all programs and stop all watering until dial is returned to the **RUN** position.

E – Wiring Compartment

- Reset Button** – This button will reset the controller. All programmed data will remain intact.
- 9-Volt Battery** – The alkaline battery will maintain the current time if power to the transformer is disconnected. However, the battery will not operate any of the watering activity (not included).
- Transformer** – The two wires from the plug-in transformer are connected to the two AC terminals.
- Terminal Strip Area** – Use to attach transformer and valve wires from their source to the controller.

TECHNICAL INFORMATION

MODELS

- SRC-600i – 6-station, indoor model
- SRC-601i – 6-station, indoor model (International)
- SRC-900i – 9-station, indoor model
- SRC-901i – 9-station, indoor model (International)

DIMENSIONS

SRC: 8 ¼" H (21 cm) x 8 ½" W (22 cm) x 2 ¼" D (6 cm)

OPERATING SPECIFICATIONS

- Station run time: 0-99 minutes in 1 minute increments
- Start times: 4 per day, per program for up to 12 daily starts
- Day schedule: 7 day calendar or true odd-even programming with 365 day calendar clock
- One touch manual start & advance
- AM/PM or 24 hour clock option
- Start time stacking

ELECTRICAL SPECIFICATIONS

- Transformer input: 120 VAC, 60 Hz (220 VAC, 50/60 Hz international use) transformer not included with export units
- Transformer output: 24 VAC, 0.75A
- Station output: 24 VAC, 0.3A per station
- Maximum total output: 24 VAC, 0.6A, includes master valve circuit
- Battery backup: 9-volt alkaline battery in separate compartment (not required for program backup)
- Non-volatile memory for program data
- Electronic short circuit protection
- Hunter Quick Check™ helps troubleshoot field wiring issues
- Master valve output: 24 VAC, 0.3A
- Overload fuse: 0.75A, spare fuse provided
- Surge protection: primary MOV-type
- Fail-safe default program:
After a prolonged power outage, waters each station 10 minutes every day beginning at 8:00 AM
- Rain sensor override compatible with most major brands
- Preset test cycle on program "C"
- UL listed

SPECIFICATION GUIDE

EXAMPLE: **SRC - 600i**

MODEL	FEATURES
SRC 600i	6-Station Controller, Indoor Model, with 120 VAC Plug-in Transformer
900i	9-Station Controller, Indoor Model, with 120 VAC Plug-in Transformer
601i	6-Station Controller, Indoor Model, without plug-in Transformer
901i	9-Station Controller, Indoor Model, without plug-in Transformer

To order additional SRC *Plus* Owner's Manuals and international labeling kits use the following item numbers:

Owner's Manual		LIT-185
International Labeling Kit Includes	French	INT-260
Faceplate label, door instruction sticker and owner's manual	Spanish	INT-261
	Italian	INT-262



PRODUCT COMPARISONS

FEATURES	Hunter SRC Plus	Rain Bird ESP Si	Irritrol Kwik Dial	Toro Green-Keeper	Irritrol Slim Dial
Dial Programming with Fewer Buttons	✓	✓	✓	✓	✓
Number of Programs	3	2	3	3	2
Number of Start Times per Program	4	3	3	3	2
Large LCD Display	✓		✓	✓	✓
Large, Professional Sturdy Cabinet	✓	✓	✓		
365 Day Calendar... True Odd/Even Watering without Reprgramming	✓			✓	✓
Rain Sensor Bypass Circuit	✓				
Pump Start/Master Valve Circuit	✓	✓	✓	✓	
Pump Start Relay (Optional)	✓				
Large Wiring Compartment for Easy Access to Wiring	✓		✓	✓	
Professional Protective Door on Cabinet	✓	✓	✓		
Provision for Conduit-Clean Installation	✓	kit	✓	✓	add-on
Time Saving Mounting Bracket	✓			✓	
Easy to View Reference Label in Controller Door	✓	✓	✓		
Foreign Language Faceplate Labeling (Optional)	✓				
Foreign Language Owner's Manuals (Optional)	✓				
Electronic Short Circuit Protection	✓		✓		
Non-volatile Memory Maintains Program Indefinitely	✓				
Hunter Quick Check™ Diagnostic Feature Helps Troubleshoot Wiring Problems	✓				
Remote Control Ready from Factory (Wiring Harness Supplied)	✓				
Central Control Compatible through Hunter IMMS™	✓				

INSTALLATION

Connecting Valves and Transformer

1. Route control wires between control valve location and controller. Typically it is recommended that an 18 AWG multi-wire sprinkler connection cable be used. This type of connection is insulated for burial and is color-coded to help keep track of your connections.
2. At the valves, attach the common wire to either solenoid wire of the valve. This is most commonly the white colored wire. Attach a separate control wire to the remaining solenoid wire and make a note of the color corresponding to each valve and the watering station it controls.
3. Secure the wires with a waterproof wire connector to protect the connection.
4. Open hinged wiring compartment door to access the terminal strip area shown in the diagram.
5. Route the valve wires through the large opening on the base of the cabinet or through $\frac{1}{2}$ inch conduit if installed. Strip $\frac{1}{4}$ inch of insulation from ends of all wires.
6. Secure the white valve common wire to the screw on the terminal marked C. With the valve common wire connected, connect the color-coded wires from the valves to their appropriate station numbers and tighten the screws.
7. Route transformer cable through the small hole in the bottom of the cabinet and connect the wires to the two screws marked AC.



Do not plug transformer into power source until the controller is mounted and all valves have been connected.

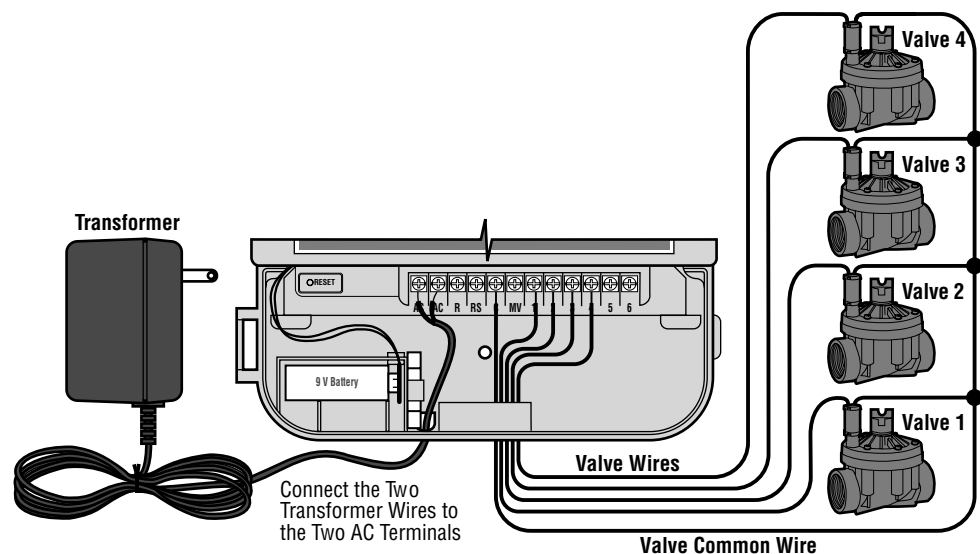

INSTALLATION (continued)

Connecting the Battery

Connect a 9-volt alkaline battery (not included) to the battery wire clip located in the lower left-hand side of the controller. The battery will protect the programmable memory during a power failure (a newly installed battery can preserve programs for up to two weeks). However, the battery will not be able to activate any of the station valves. Electrical power must resume before watering will continue.

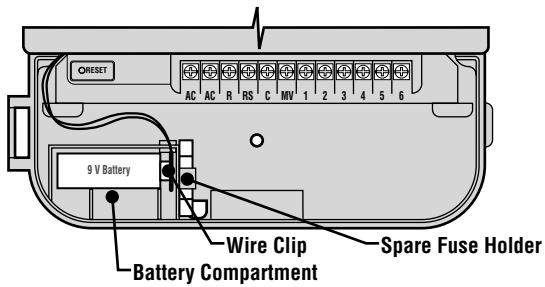

Connecting a Master Valve



NOTE: Complete this section only if you have a master valve installed. A master valve is a normally closed valve installed at the supply point of the main line that opens only when the automatic system is activated.

1. At the Master Valve, attach the common wire to either solenoid wire of the valve. Attach a separate control wire to the remaining solenoid wire and make a note of the color corresponding to the master valve.
2. Route these wires to the controller the same way as the station valves. The white common wire will still go to the screw slot marked C. The additional wire coming from the master valve will go in the screw slot marked MV.

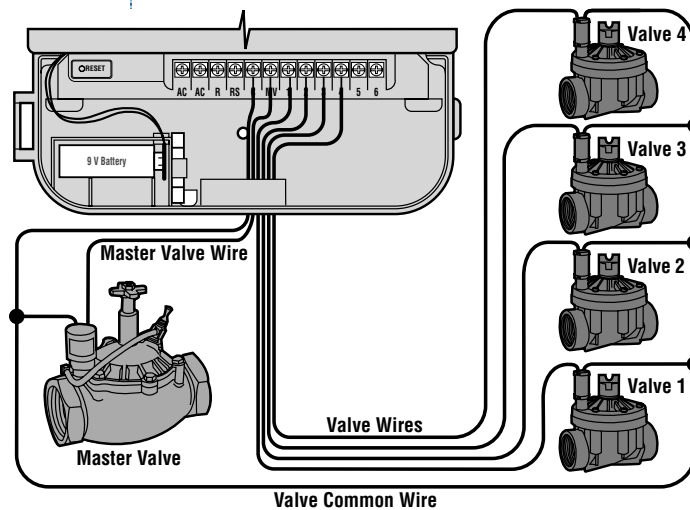

Connecting a Pump Start Relay



NOTE: Complete this section only if you have a pump start relay installed. A pump start relay is an electronic device that uses a current from the controller to actuate a separate electrical circuit to energize a pump to provide water to your system.

The controller should be mounted at least 15 feet (4.5m) away from both the pump start relay and the pump. When a pump start relay comes on it sends out surges that may potentially cause damage to a controller that is mounted too close. When a pump is to be operated by the controller, a pump start relay must be used. Hunter offers a full range of pump start relays for most applications.

1. Route a wire pair from the pump relay into the controller housing.
2. Connect common wire to the screw slot C (Common) and the remaining wire from the pump relay to the MV screw slot.

Relay current draw must not exceed .35 Amps. **Do not connect controller directly to pump – damage to controller can result.**

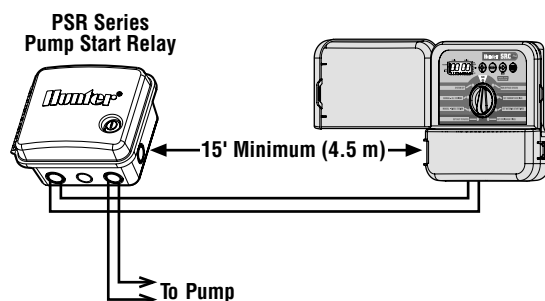

To prevent pump damage, connect a jumper wire from any unused station terminal to a station terminal with a control valve installed. If there is a power failure and the back up battery fails, a default program will operate all stations for 10 minutes. Unused stations will still attempt to operate the pump, potentially causing damage to the pump. If connected to an operational valve, the result would be an over watered station instead of a damaged pump.

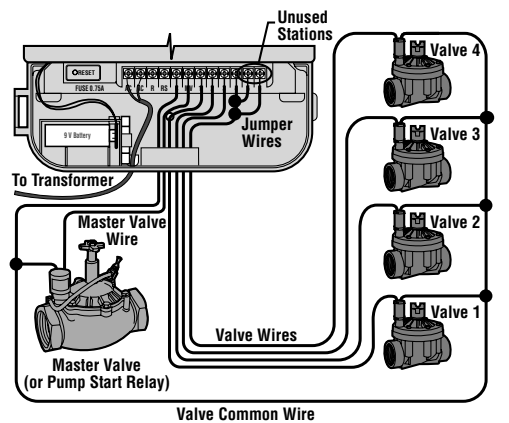

NOTE: If a rain sensor is installed with your SRC along with a pump start relay, the relay common must be connected to the RS terminal.



INSTALLATION (continued)

Connecting a Weather Sensor

A Hunter Mini-Clik® rain sensor or other type of interrupt weather sensor can be connected to the SRC Plus. The purpose of this sensor is to stop watering when precipitation is sufficient. The sensor connects directly to the controller and allows you to easily override the sensor by using the RUN (BYPASS SENSOR) position on the dial.

1. Route the wires from the rain sensor up through the same opening used for valve wiring.
2. Connect one wire to the RS terminal and the other to the C terminal.
3. Connect the valve common from the field to the RS terminal.



NOTE: If a pump relay is being used, the relay common must also be connected to the RS terminal.

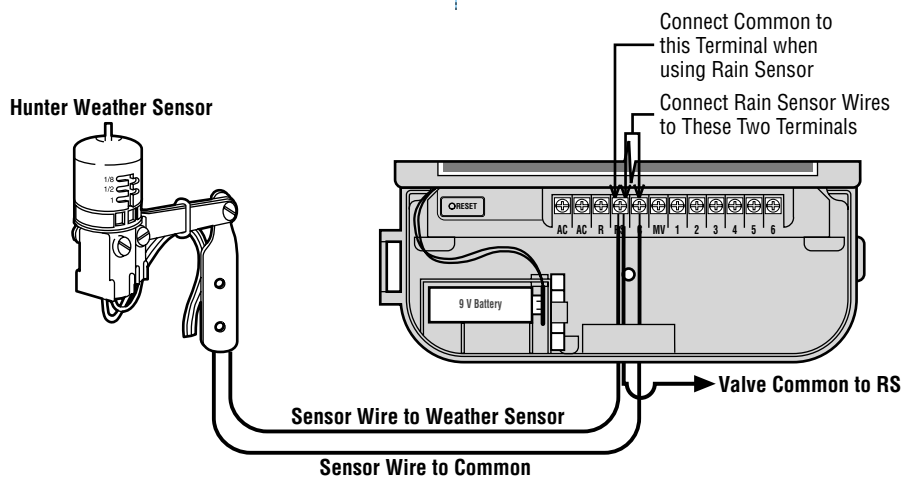

PROGRAMMING

The SRC *Plus* Controller is easy to program. The easy to understand dial design allows you to step through the process of programming and activate manual watering with a twist of the wrist.

The SRC display shows time and day when the controller is idle. The display changes when the dial is rotated to indicate the specific programming information to enter. When programming, the flashing portion of the display can be changed by pressing the **+** or **-** buttons. To change something that is not flashing, press the **↻** button until the desired field is flashing.







The SRC also provides a reference label that is attached to the inside of the controller door (no more lost or misplaced instructions!). And, extra space is provided to write in sprinkler station location information.

A full three programs, each with the ability to have four daily start times, permit plants with different watering requirements to be separated on different day schedules. Multiple start times permit morning, afternoon, and evening watering, perfect for the establishment of new lawns and thirsty annual flowers. A built-in 365 day calendar clock accommodates odd/even watering restrictions without requiring monthly reprogramming. Or just simply designate the days of the week you want to water. The SRC makes it easy.

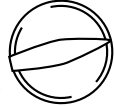

NOTE: A basic programming rule is that whatever symbol or character is flashing will be the item programmed. For instance, if the hour is flashing when setting the time, the hour can be changed or programmed. For illustration purposes, flashing characters are in GRAY type.

Setting the Date and Time

1. Turn the dial to the SET CURRENT DATE/TIME position. 
2. The current year will be flashing in the display: Use the **+** or **-** button to set the year. After setting the correct year, push the **↻** to proceed to setting the month. 
3. The month and day will be in the display: The month will be flashing. Use the **+** or **-** button to set the month. Push the **↻** to proceed to setting the day. 
4. The day will be flashing: Use the **+** or **-** button to set the day of the month. (The day of the week is automatically indicated by an arrow in the bottom of display pointing to the day.) Push the **↻** button to proceed to setting the time. 
5. The time will be displayed, and an arrow will be flashing on AM. Press the **+** or **-** buttons to select AM, PM, or 24 HR. Press the **↻** to proceed to setting the hours. 
6. Hours will be flashing. Press the **+** or **-** button to change the hour shown on the display. Press the **↻** to proceed to setting the minutes. 
7. Minutes will be flashing. Use the **+** or **-** button to change the minutes shown on the display. The date, day and time have now been set and the dial may be returned to the RUN position. 

PROGRAMMING (continued)

Setting Watering Start Times

1. Turn the dial to the SET WATERING START TIMES position.



2. The factory preset is set on program A. If necessary, you can select program B or C by pressing the **PRG** button.



3. Use the **+** or **-** button to change the start time. (The start times advance in 15 minute increments.) Hold either button down for 1 second to change times rapidly.
4. Press the **➡** button to select the next start time, or press **PRG** for the next program.

NOTE: One start time will activate all stations sequentially in that program. This eliminates the need to enter each station's start time. Multiple start times in a program can be used for separate morning, afternoon, or evening watering cycles.



Eliminating a Program Start Time

With the dial set to the SET WATERING START TIMES position, push the **+** or **-** button until you reach 12:00 AM (Midnight). From here push the **➡** button once to reach the OFF position.

NOTE: If a program has all four-start times turned off, then that program is off. (All other program details are retained). Because there are no start times, there will be no watering with that program. This is a convenient way to stop watering on one program only without turning the dial to the OFF position.



Setting Station Run Times

(Length of Watering for Each Area)

1. Turn the dial to the SET STATION RUN TIMES position.
2. The display will show the last program selected (A, B, or C) the station number selected, and the run time for that station will be flashing. You can switch to another program by pressing the **PRG** button.
3. Use the **+** or **-** button to change the station run time on the display.
4. Press the **➡** button to advance to the next station.
5. Repeat steps 3 and 4 for each station.
6. You can set station run times anywhere from 0 to 99 minutes.
7. You can move between programs while staying on the same station. However, it is recommended that one program is completed before going on to the next program.



SET STATION RUN TIMES



NOTE: Jumping between programs can be confusing and may result in program entry errors.



Setting Days To Water

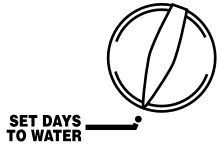

1. Turn the dial to SET DAYS TO WATER.
2. The display will show the last program selected (A, B, or C). You can switch to another program by pressing the **PROG** button.
3. The controller will display currently programmed active day schedule information. This dial position provides different watering options: choose to water on specific days of the week, or choose to water only on odd days or even days. Each program can operate using only one type of water day option.

Selecting Specific Days of the Week to Water

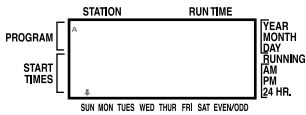

1. With the arrow cursor on a specific day (the cursor always starts with Sunday), press the **+** button to activate a particular day of the week to water. Press the **-** button to cancel watering for that day. After pressing a button the cursor automatically advances to the next day.
2. Repeat step 1 until all desired days have been selected. The selected days arrows will show on the display to indicate their status as ON. The last solid arrow is the last day of watering for that program.

Selecting Odd or Even Days

This feature will use a numbered day of the month for watering instead of specific days of the week (Odd days 1st, 3rd, 5th, etc.; Even days 2nd, 4th, 6th, etc.).

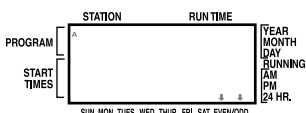

1. Press the **+** button until the arrow cursor is above either EVEN or ODD on the display.

2. Press the **+** button to select or the **-** button to cancel either Odd Days or Even Days. The previous selected days of the week will revert to active if Odd Days or Even Days is cancelled.



NOTE: The 31st of any month and February 29 are always “off” days if Odd watering is selected.

Run

After programming is complete, turn the dial to RUN to enable automatic execution of all selected programs and start times. Watering will not occur unless dial is in the RUN or RUN (SENSOR BYPASS) position.

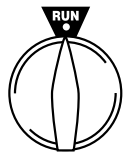

Weather Sensor Bypass

With this built-in feature, there is no need for an additional manual bypass switch when using rain sensors (the SRC works with the Hunter Mini-Clik[®], plus some other rain, wind or freeze sensors on the market today). If the sensor is preventing system operation, just turn the dial to RUN (BYPASS SENSOR) and the weather sensor will be overridden.

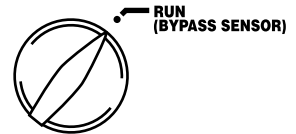



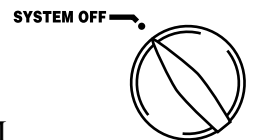

System Off

Valves currently watering will be shut off after the dial is turned to the SYSTEM OFF position for two seconds. All active programs are discontinued and watering is stopped. To return controller to normal automatic operation, simply return dial to RUN position.









PROGRAMMING (continued)

Manually Run a Single Station

1. Turn dial to the MANUAL-SINGLE STATION position. 
2. Station run time will flash in the display. Use the  button to move to the next station. You may use the  or  button to select the amount of time for a station to water.
3. Turn the dial clockwise to the RUN position to run the station (only the designated station will water, then the controller will return to automatic mode with no change in the previously set program).

Manually Run All Stations







1. Turn dial to MANUAL-ALL STATIONS. 
2. You can select program A, B, or C by pressing the  button.
3. Press the  button until desired starting station is displayed.
4. Station run time will flash in the display. Use the  or  buttons to select the amount of run time for the station to water.
5. Use the  button to move to the next station.
6. Repeat steps 3 and 4 to customize each station.
7. Press the  button until you reach the station that you would like watering to begin.
8. Return dial to RUN (custom program will water, then controller will return to automatic mode with no change in the previously set program).



NOTE: The station that is on the display when you turn the dial to RUN will be the first station to run. The controller will then proceed to water in sequential order only. It will not water previous stations. Example: If you turn the dial to RUN with the display reading station 3. The controller will water stations 3 to 9 in the program, but not return to stations 1 and 2.







One Touch Manual Start and Advance

You can also activate all stations to water without using the dial.

1. Hold down the  button for 2 seconds.
2. This feature automatically defaults to program A. You can select program B or C by pressing the  program.
3. The station number will be flashing. Press the  button to scroll through the stations and use the  or  buttons to adjust the station run times. (If no buttons are pressed during step 2 or 3, the controller will automatically begin program A.)
4. Press the  button to scroll to the station you wish to begin with. After a 2 second pause, the program will begin.

This feature is great for a quick cycle when extra watering is needed or if you would like to scroll through the stations to inspect your system.



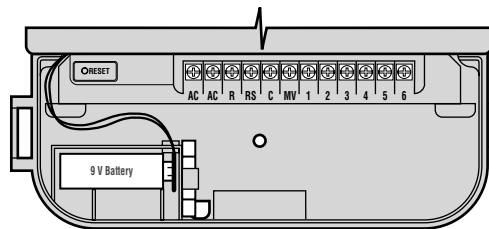

Clearing Controller's Memory/Resetting Controller

If you feel that you have misprogrammed the controller, there is a process that will reset the memory to factory defaults and erase all programs and data that have been entered into the controller. Press the ,  and  and hold them down simultaneously. Press and release the reset button then release the ,  and  buttons. Time display should show 12:00 AM. All memory has been cleared and the controller may now be reprogrammed.



Hunter Quick Check™

Irrigation professionals are continuously looking for ways to more efficiently and effectively diagnose programs in the field. Instead of having to physically check each field wiring circuit for potential problems, the user can run the Hunter Quick Check circuit test procedure. This circuit diagnostic procedure is very beneficial because of its ability to aid in quickly identifying “shorts” commonly caused by faulty solenoids or when a bare common wire touches a bare station control wire.

To initiate the Hunter Quick Check test procedure; Press the , ,  and  and buttons simultaneously. In the standby mode, the LCD will display all segments (helpful when troubleshooting display problems). Press the  button to begin the Quick Check test procedure. Within seconds, the system searches all stations in an effort to detect a high current path through the station terminals. When a field wiring short is detected, an ERR symbol preceded by the station number will momentarily flash on the controller LCD display. After the Hunter Quick Check completes running this circuit diagnostic procedure, the controller returns to the automatic watering mode.



TROUBLESHOOTING GUIDE

PROBLEM	CAUSES	SOLUTIONS
Display indicates irrigation but station does not water.	Faulty or miswired valve.	Check valve and valve wiring.
	Faulty pump or pump relay.	Check pump and pump relay. Replace if defective.
	No water pressure to supply.	Turn on main system water system.
Display is blank.	No AC power reaching controller.	Verify AC power and wiring. Correct any errors. Check transformer output.
	Controller may be damaged by power surge.	Call dealer.
Time of day display is blinking.	Unit has just been powered up for the first time.	Set time/date.
	Extended power outage has occurred that has drained battery.	Replace battery and reprogram controller.
	Short power outage has occurred but backup battery is dead.	Replace battery and reprogram controller.
The display reads "ERR".	Electrical noise is entering the system, through the smart port wiring harness.	Check the SmartPort® wiring harness. If the wires were extended then they will need to be replaced with shielded cable. Contact your local distributor for information on shielded cable.
The display reads "P ERR".	There is a ground fault in the wire to the pump start or master valve.	Check the master valve or pump start wire for continuity. Replace or repair the broken wire. Check that all wire connections are good and water tight.
The display reads a station number and ERR, such as "2 ERR".	There has been a ground fault with the wire leading to that station.	Check the station wire for continuity. Replace or repair broken wire. Check that all wire connections are good and water tight.
The display reads "NO AC".	There is no AC power present.	Check to see if the transformer is properly installed.
Rain sensor does not suspend irrigation.	Rain sensor is defective or miswired.	Verify operation of sensor and proper wiring.
	Controller is in the RUN (BYPASS SENSOR) position.	Return dial to the run position.
Frozen display.	Power Surge.	See "Clearing Controller's Memory/ Resetting Controller" on page 19.
Automatic irrigation does not start at start time and controller is not in the system off mode.	AM/PM of time of day not set correctly.	Correct AM/PM of time of day.
	AM/PM of start time not set correctly.	Correct AM/PM of start time.
	Start time is disabled (Set for Off).	
	Rain Sensor is preventing operation.	Turn dial to RUN (BYPASS SENSOR).
	Controller is not receiving AC power.	Check AC connections.
Controller waters the same area more than one time.	Too many start times entered in program.	One start time activates a complete cycle. See "Setting Start Times."

SRR Remote Control

PRODUCT OVERVIEW

Finally, homeowners can enjoy the convenience of true remote control. Now, there's no need to walk back to the controller to start and stop a manual watering cycle when doing maintenance or repair work on an irrigation system.

With the SRR – A Simple and Reliable Remote Control System for use with our SRC *Plus* controller. Remote control is available at a price homeowners can afford.

The SRR transmitter is made of sturdy ABS and has no external antenna to get in the way. It features a large LCD and four-button operation. Don't let its size fool

you – while it's small enough to fit in your shirt pocket, it has an open field range of up to 450 feet.

The large LCD display and simple four-button control make the SRR a snap to use. Simply press the **◆** or **◆** keys to display the station or program you want to turn on or off, then press the **ON** or **OFF** button – what could be easier? Don't worry about forgetting to turn off the SRR. After several minutes of inactivity the unit turns itself off to extend battery life. Then, the unit can be turned back on by touching any button. A standard 9-volt alkaline battery will last an entire season.



PRODUCT FEATURES AND BENEFITS

Internal Antenna on Transmitter...

Out of sight, out of mind

The SRR's transmitter has no external antenna that can be broken or lost.

Sturdy ABS Construction...

Tough and rugged for any user

The SRR transmitter and receiver are made of heavy-duty ABS plastic that will withstand the toughest conditions and repeat uses.

Large LCD Display and Four-Button Operation...

Easy to view and a snap to operate

Simply press the **▲** and **▼** buttons to display the station or program that is desired, then press the "ON" or "OFF" buttons. After several minutes of inactivity, the SRR turns itself off to extend battery life. It can be reactivated by touching any button.



Small and Compact Size...

Slips into shirt or pants pocket

Both the transmitter and receiver are small enough to fit into the palm of your hand. And because they are so compact, they can be easily transported in a shirt or pants pocket during daily uses.

Standard 9V Alkaline Battery...

Easy to purchase and lasts a long time

Any convenience, hardware or building supply store carries standard 9V alkaline batteries.

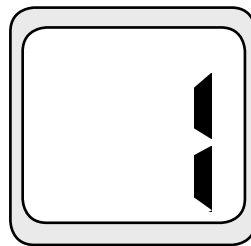

8 Different Remote-Activated Run Time Settings...

Quick or lengthy, for total versatility

The SRR can be programmed for 8 different run time remote-activated settings (1, 2, 5, 10, 15, 20, 25 and 30 minute increments are available) for the many irrigation functions that may be required. The default setting is 10 minutes.

User Programmable Address...

Added user security

Both the SRR transmitter and receiver have an “address” that they use when communicating with each other. If the addresses do not match, the receiver will ignore the transmission. The SRR comes from the factory with both addresses set at 0. The transmitter address may be changed to any setting from 0-127 for added security. The receiver will then “learn the address.” The programmable address is useful for areas where multiple homes or buildings are utilizing SRR remotes.

Programmable Number of Stations Controlled...

Customize the remote to the number of stations on the controller

The SRR is fully reprogrammable and can access up to 48 stations, allowing for increased flexibility as well as use with future controller products.

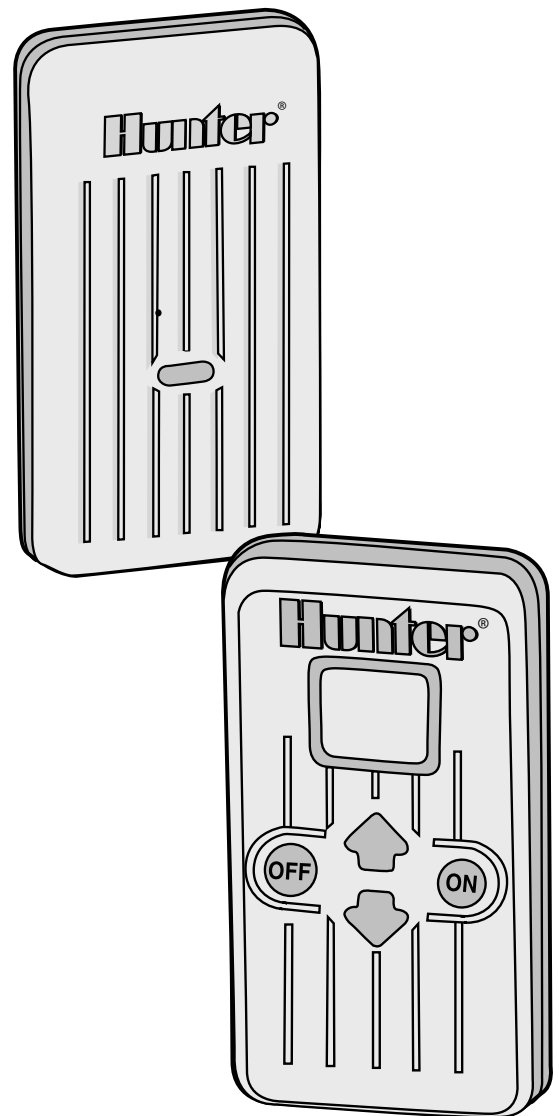

SRR COMPONENTS

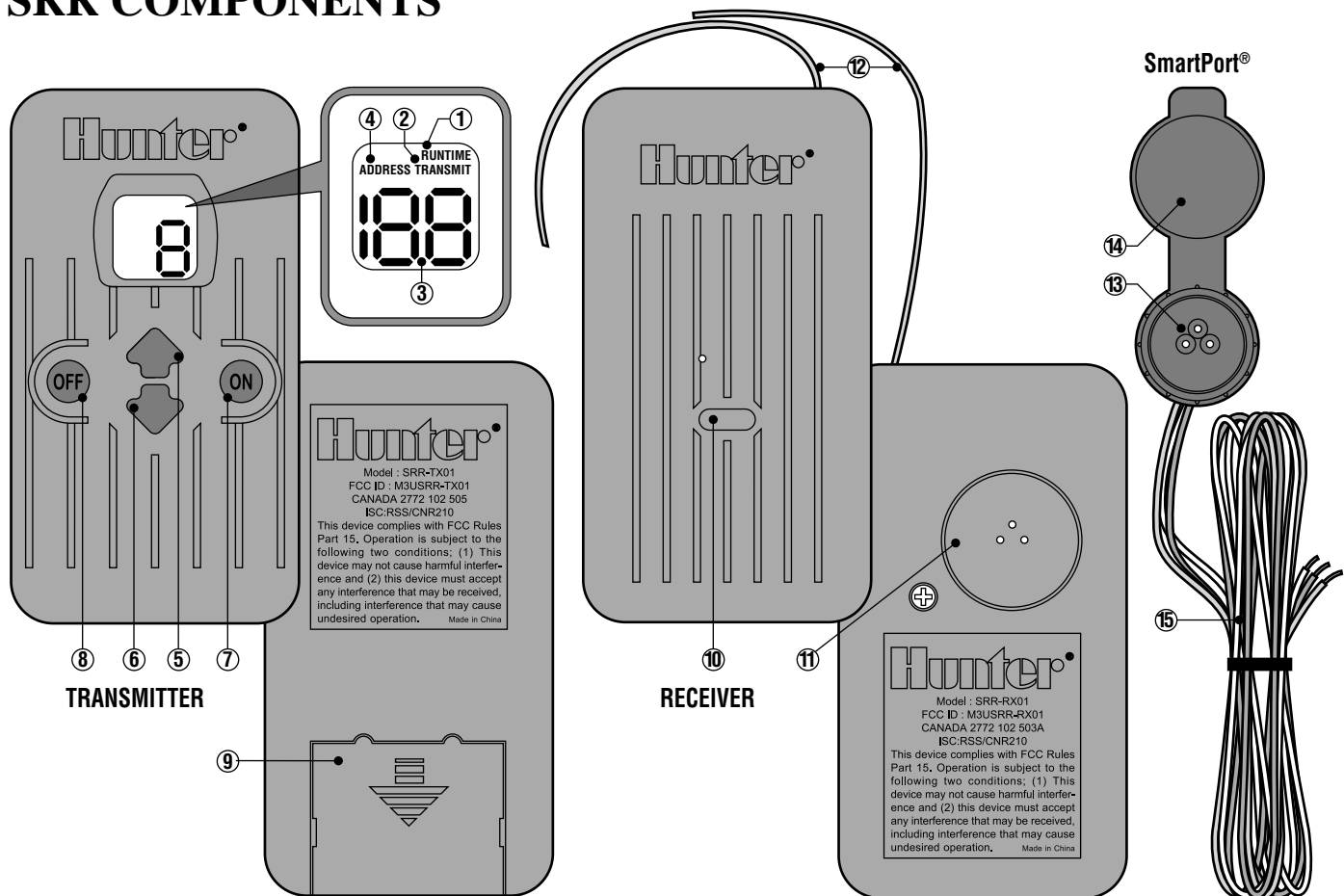

TRANSMITTER

A. LCD Display

1. **Run Time** – Indicates the Station Run Time is being set when flashing.
2. **Transmit** – Indicates that the Transmitter is transmitting the programmed data to the receiver.
3. **Main Display** – Indicates various times and values.
Number – Indicates either Station Run Time (1 to 30) or Station number (1 to 48).
On – Indicates Transmitter is turning on a particular station.
Off – Indicates Transmitter is turning off a particular station.
Program (A, B, C) – Indicates program selected.
4. **Address** – Indicates that a new address for transmitting between the Transmitter and the Receiver is being set.

B. Control Buttons

5. **▲** – Increases the selected flashing display.
6. **▼** – Decreases the selected flashing display.
7. **ON** – Selects the selected flashing display.
8. **OFF** – Cancels the selected flashing display.

C. Other

9. **Battery Cover** – Covers compartment for 9-volt alkaline battery.

RECEIVER

10. **Control Button** – Hold button down when plugging Receiver into SmartPort® when programming a new address.
11. **SmartPort® Outlet (Male)** – Outlet on back of Receiver that plugs into the SmartPort® harness.
12. **Antenna** – Receives signals from Transmitter from up to 450'.

SmartPort®

13. **SmartPort® Outlet (Female)** – Outlet on front of SmartPort® that plugs into the SRR Receiver or other Hunter product.
14. **Rubber Cover** – Protects SmartPort® from dirt and weather.
15. **Control Wires** – Red, white, and blue wires that connect to the terminal strip area of the controller.

INSTALLATION AND PROGRAMMING

Smart Port® Wiring Harness

Preparing the Communication Port

To utilize the SRR Remote Control System, your Hunter controller must be equipped with the SRR SmartPort® wiring harness. This wiring harness provides the communication port where the SRR receiver is attached. The SmartPort® installation instructions are included in the SRC *Plus* installation and programming instructions. Additional wiring harnesses can be purchased separately to allow you to utilize the transmitter and receiver with additional controllers.

Installing the SRR Remote Wiring Harness

1. Install a ½" female threaded "Tee" in the field wiring conduit approximately 12" below the SRC controller. (Note: the harness may be installed out doors by first bringing the conduit through an exterior wall, then installing the appropriate fitting).
2. Feed the red, white and blue wires of the harness through the base of the "Tee" and into the controller wiring compartment as shown in Figure 1.
3. Screw the harness housing into the "Tee" (or other fitting) as shown in Figure 1.

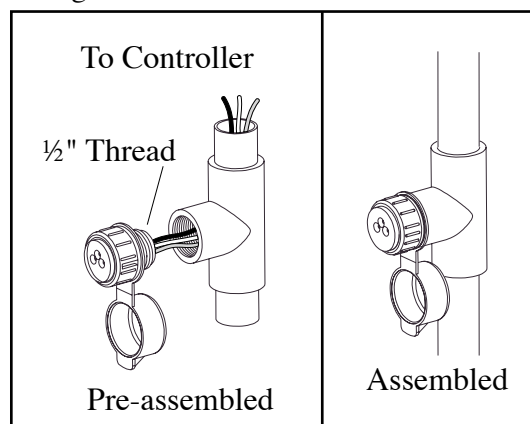

Fig. 1

4. Attach the red, white and blue wires from the harness to the terminal block of the controller as shown in Figure 2.

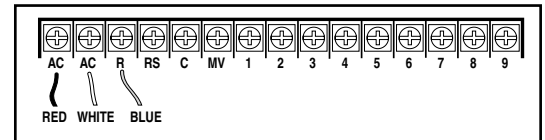
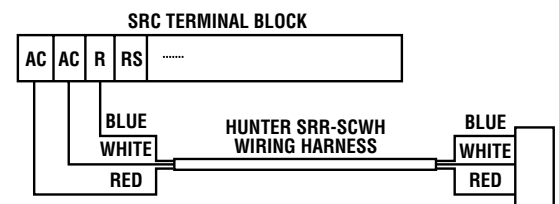

Fig. 2

Extending the Wiring Harness

Any extension of the wiring on the harness *may* result in an error message in the controller display and possible malfunction of the remote unit due to radio interference. In some situations, lengthening of the harness may work fine, in others it may not work at all (it is site specific). In either case, extending the wiring harness should be done using shielded cable to minimize the possible effects of electrical noise. Hunter's SCWH is a wiring harness with 25 feet of shielded cable which makes extending the receiver connection fast and simple.



Transmitter

Preparing the Transmitter for Use

Your SRR System is designed to work right out of the box. This means that other than installing the battery, you may choose to skip this entire section. However, we recommend you read it because with a few simple steps you can customize your SRR to add functionality and security to your system. Be aware that if you change your transmitter address or maximum station number as described

INSTALLATION AND PROGRAMMING (continued)

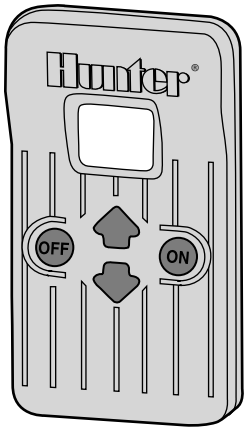

below, you should make a note of the new settings since, when the battery is removed and a new one installed, the transmitter will revert back to the original settings.



Installing the Transmitter Battery

Your SRR Transmitter requires a 9-volt alkaline battery. To install the battery, slide open the battery door (on the back of the transmitter), attach the battery to the clip, insert the battery, and slide the door shut again. (When changing the battery, push the battery down in the case to reveal the battery clip before attempting to remove the battery from the case.)



Changing the Transmitter Address

Both the SRR Transmitter and Receiver have an “address” that they use when communicating. If the addresses do not match, the Receiver will ignore the transmission. Your SRR comes from the factory with both Transmitter and Receiver address set to 0. You may change the address to any value from 0-127 for added security. *Note that if you change the Transmitter address, the Receiver must “learn” the new address as described in “Preparing the Receiver for Use” section.* To change the Transmitter address follow the steps below:

1. If the unit is OFF (no display), power the Transmitter by pressing any of the buttons for at least 1 second then releasing the button. The Transmitter will first illuminate the entire display for 1 second then display the active station.

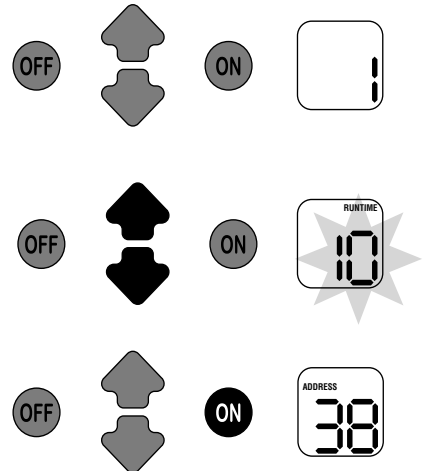
2. Simultaneously press the  and  buttons, until the word “RUN TIME” along with the current Run Time is displayed. The display will be blinking at this point.



3. While the display is blinking and showing the current Run Time, Press the “ON” button. The word “ADDRESS” will now illuminate and the current address will be blinking. Note that if more than 5 seconds go by without a button being pressed, the Transmitter will revert back to displaying the active station.
4. Use the  and  buttons to change the address to any value between 0 and 127. Then do not touch any of the buttons for 5 seconds and the display will stop blinking, and return back to the active station.

Receiver

Preparing the receiver for use

As stated earlier, your SRR System is designed to work right out of the box.

If you have decided to change your Transmitter address as described in the previous section, you must allow the Receiver to “learn” this new address.

Once learned, the only way to remove the address from Receiver memory is to learn a different address. This can be done by following the simple steps outlined on the next page.

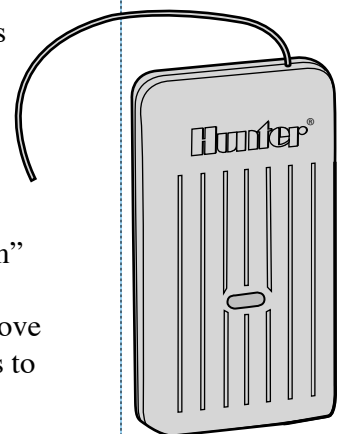

Changing the Receiver Address

1. Hold down the single button on the face of your Receiver while you are plugging it into an active wiring harness (one connected to a powered controller). When this is done, the Receiver will beep 4 times.
2. After the Receiver starts to beep, release the button.
3. Press either the “ON” or “OFF” button of your Transmitter.
4. The Receiver will beep 4 additional times indicating that it has learned the new Transmitter address and will respond only to it from this point on.



NOTE: The SRR remote receiver should not be permanently installed in an outdoor or unsheltered location.

Run Time

You have the ability to adjust the amount of time that a station will run once it has been turned on by your SRR System. This does not affect the run time programmed into your controller. This adjustment is made at the transmitter as described below.

To change the Run Time follow the steps below:

1. If the unit is OFF (no display), power the transmitter up by pressing any of the buttons for at least 1 second then releasing the button. The transmitter will first illuminate the entire display for 1 second then display the active station.

2. Simultaneously press the \blacklozenge and \blacktriangledown buttons, until the word “RUN TIME” along with the current Run Time is displayed (default is 10 minutes). The display will be blinking at this point. If more than 5 seconds go by without a button being pressed, the Transmitter will revert back to displaying the active station.
3. Use the \blacklozenge or \blacktriangledown buttons to change the Run Time to any of 8 settings ranging from 1 to 30 minutes. Then do not touch any of the buttons for 5 seconds and the display will stop blinking, and return back to the active station.

Activating a Station with the SRR Remote Control System

The SRR System will allow you to remotely turn on and off any station on your SRC *Plus*, Pro-C, and ICC with the press of a button. Once on, the station will run for the run time you have designated in the remote.

To remotely activate a station or program follow the steps below:

1. Plug the Receiver into an active wiring harness (one attached to a powered controller) and wait for 2 beeps indicating that the Receiver is ready.
2. If your Transmitter is not on (no display), press any button for at least 1 second and release. The Transmitter will first illuminate the entire display, then display the active station.

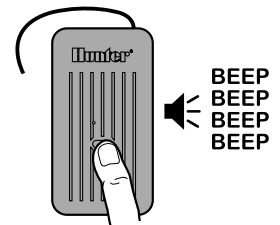

INSTALLATION AND PROGRAMMING (continued)

3. Use the ▲ or ▼ buttons to display the station or program you would like to start.

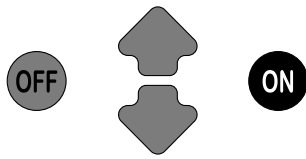

4. Momentarily press the “ON” button to start the station or program.

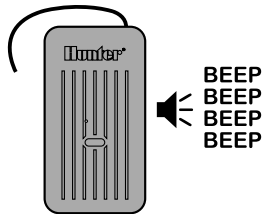

The Transmitter will display the word “TRANSMIT” and will flash for about 4 seconds indicating that it is sending the command to the Receiver. If you are near the Receiver, you will hear it beep 2 times, indicating that it has received the command.

5. Press the “OFF” button to turn off any station that is on. The display will again read “TRANSMIT” and flash, and the Receiver will again beep twice. The SRR System is designed to turn one station on at a time. Therefore, turning a station on while another station is already on will cause the first station to turn off.

Note: The SRR remote can activate any station on the controller whether the controller dial is in the “System Off,” “Run” or “Run/Bypass Sensor” modes.



If a sensor device has been wired to the controller, the SRR remote will not override the sensor for manual operation unless the controller dial is in the “Run/Bypass Sensor” position.

Changing the Maximum Station Number

Your SRR Transmitter comes from the factory with the maximum station number set to 9. This means that when you use the ▲ and ▼ buttons to change the station, you may change it to any number between 1 and 9. However, if you only have a 6-station controller, you will never need to access stations 7-9. Likewise, perhaps you will own a future Hunter controller with more than 9 stations. In this case you would want to access the stations above 9. The SRR Transmitter allows you to set the maximum station number as follows:

- If the unit is OFF (no display), power the Transmitter up by pressing any of the buttons for at least 1 second then releasing the button. The Transmitter will first illuminate the entire display for 1 second then display the active station.

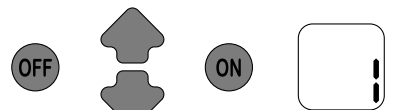

- Simultaneously press the ▲ and ▼ buttons, until the word “RUN TIME” along with the current Run Time is displayed. The display will be blinking at this point.

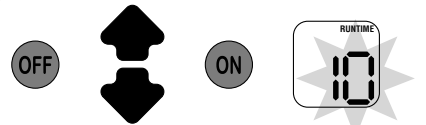

- While the display is blinking and showing the current address, press the “ON” button. The display will continue to blink, but the word “ADDRESS” will be illuminated.

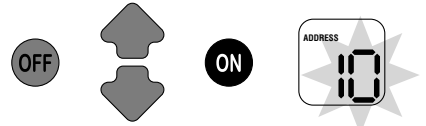

- Press the “ON” button again. The display will continue to blink, but the word “ADDRESS” will no longer be illuminated.

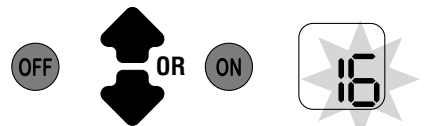
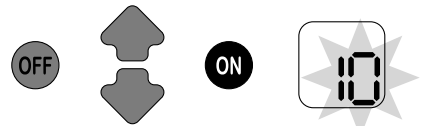

A WORD ABOUT RANGE

5. Use the ▲ or ▼ buttons to change the maximum station number to the value you desire. Then, do not press any buttons for 5 seconds and the display will stop blinking and return to the active station number.
6. You may now change the active setting to the new maximum station value.

Maximizing Operating Range

There are many factors which influence operating range. Listed below are a few things you can do to assure you are getting the maximum range possible.

1. Do not install the outlet of the wiring harness (that the Receiver connects to) near large sources of metal such as power meters, water pipes, and aluminum siding.
2. Do not install the outlet of the wiring harness in a basement or underground location. The higher, the better.
3. For maximum range in all directions from the Receiver, the Receiver antenna should be pointed straight up (vertically). If the Receiver is mounted with its antenna oriented horizontally, reception will be very good if the Transmitter is on either side of the antenna, but very poor if it is facing the end of the Receiver antenna.
4. When operating the Transmitter, hold the Transmitter as vertical as possible and turn and face the direction of the Receiver, even if it is several hundred feet away.

There are many claims being made about the range of various remote control systems, whether they be for auto alarms, garage doors, or irrigation systems for that matter. The published range for the SRR System is up to 450 feet. Most users will achieve this range or more, but a few may not. It is the attempt of this section to educate the user about those factors that influence operating range. We believe that we have achieved the maximum performance available on this frequency.

Here's why...

The range of any remote control system is dependent on many factors. These include the terrain at a particular site, obstructions such as buildings and walls, the strength of the various interfering signals, the sensitivity of the Receiver, the ability of the Receiver to reject "unwanted" signals, and the strength of the Transmitter. Since it is impossible to control the obstructions, terrain at a site, and the strength of interfering signals, it is impossible to guarantee an operating range under all conditions. However, we have done everything under our control to maximize the operating range of this system.

The SRR Transmitter has been designed to transmit the maximum power allowed by the FCC. Furthermore, it has special circuitry to assure that this maximum output power is maintained until just before the battery goes dead. Other transmitters emit less and less power as the battery wears down. The Receiver employs a reception method far superior to that used in a typical garage door opener or auto alarm.

The SRR has been designed to give you simple, reliable operation for many years.

TROUBLESHOOTING GUIDE

PROBLEM	CAUSES	SOLUTIONS
Transmitter display is blank.	Transmitter is off.	Press any button for 1 second.
Can't access all the desired station on the Transmitter.	Maximum station number is set wrong.	See "Changing the Maximum Number".
Receiver doesn't beep two times after plugging it in.	SmartPort® is not connected properly. Controller has no power.	Recheck SmartPort® wiring. Check controller power.
Receiver beeps twice after plugging it in, but won't respond to Transmitter.	Receiver and Transmitter address don't match.	Relearn address at receiver.
Transmitter display stays on.	Transmitter will turn off automatically.	Wait approximately 5 minutes without pressing any buttons. Transmitter will "fall asleep."
"ERR" message in controller display when controller is in the radio run position.	SmartPort® wiring leads have been extended and are receiving radio interference.	Replace lengthened wire with shielded cable to prohibit interference. Use Hunter SRR-SCWH.
Receiver does not receive signal from remote held at close range.	Mismatch of addresses in transmitter and receiver.	Reset address of receiver.
Remote has short range (i.e. less range than 100 feet).	Check for interference causes.	See "Maximizing Operating Range" and "A Word About Range" on page 29.

TECHNICAL INFORMATION

MODELS

SRR-KIT – Transmitter, receiver, wiring harness and owners manual

SRR-TR – Transmitter

SRR-R – Receiver

SRR-SCWH – Connection Kit with 25' shielded cable

DIMENSIONS

Transmitter	Receiver
• Height: 4 ³ / ₄ " (12 cm)	• Height: 4 ³ / ₄ " (12 cm)
• Width: 2 ¹ / ₂ " (6 cm)	• Width: 2 ¹ / ₂ " (6 cm)
• Depth: 1 ¹ / ₄ " (3 cm)	• Depth: 1" (2.5 cm)

OPERATING SPECIFICATIONS

- Address range: 0-127
- Maximum stations supported: 48
- Run times: Eight settings from 1 to 30 min
- Range: Up to 450' (137 m)*

ELECTRICAL SPECIFICATIONS

- Power Source-Transmitter: 9V alkaline battery
- Power Source-Receiver: 24 VAC, 0.010 Amps from controller
- Transmitter type: Saw Stabilized
- Receiver Type: Superheterodyne
- System Operating Frequency: 315 MHz
- Install SmartPort® up to 50 feet from controller (use shielded cable wiring harness)

* See a "A Word About Range"

DEFAULT SETTINGS

- Address = 0 (may be varied from 0-127)
- Number of stations = 9 (may be varied from 1-48)
- Run Time: 10 minutes

SPECIFICATION GUIDE

EXAMPLE: **SRR - KIT**

MODEL	FEATURES
SRR	KIT = Transmitter, Receiver and Wiring Harness SCWH = 25' Shielded Cable Connection Kit TR = Transmitter R = Receiver

Additional SRR owner's manuals can be ordered from Hunter (item LIT-220).

INSTALLATION DETAILS

Receiver Mounted Indoors

This installation is ideal for situations when the SRR system will be left permanently connected to the controller in an indoor area.

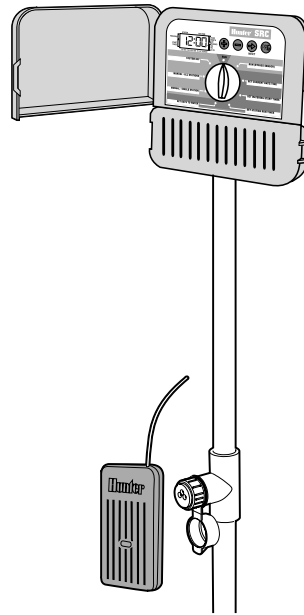

Connection of Receiver on a Temporary Basis from Outside of a Garage or Building

This installation is ideal for situations where a contractor desires the ability to access and operate a controller from outside of a locked building or garage. However, the SRR receiver must be removed from the SmartPort® and the weather resistant cap placed back on the outlet after each use.

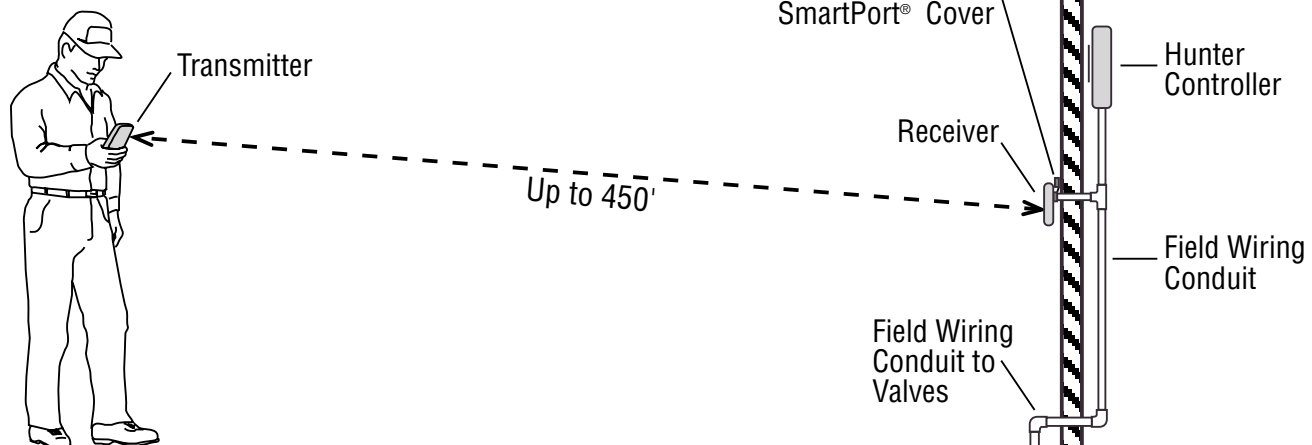



Hunter®

Hunter Industries Incorporated • The Irrigation Innovators
1940 Diamond Street • San Marcos, California 92069 • TEL: (1) 760-744-5240 • FAX: (1) 760-744-7461
www.HunterIndustries.com

© 2004 Hunter Industries Incorporated
P/N 700432 LIT-220 5/04